

气动阀 (Air-Operated Valves)

- 活接头连接。
- 本体可选材质(PTFE/PVC/CPVC/PP)。
- 超低粉尘处理(表面粗糙度加工、精密洗净、平面构造)。
- MRM独自的安全构造(高压对策及热循环对策)。

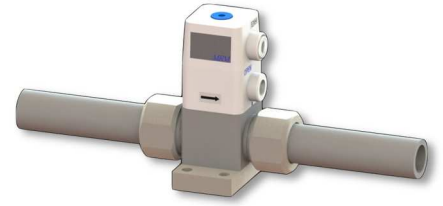

型号表示方法 (How to order)

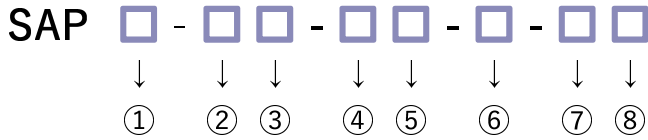

型号选定例 (Model Number Selection example)

SAP2-15PV-UA1-5-1B

: NC, 16A, PVC Body, PVC Union, FKM O-ring, ON/OFF, Bottom mounting

① 制动方式 (Operation method)	
2	NC (Normal Close)
9	NO (Normal Open)

◎ : 标准在庫品 (Standard stock)
 ○ : 受注生産品 (Made to order)
 - : 无在庫 (Not stock)

② 阀门尺寸 (Valve size)		15	20	25
		16A	20A	25A
③ 本体材质 (Body material)				
TF	PTFE	○	○	○
PV	PVC	◎	◎	○
CV	CPVC	○	○	○
PP	PP	○	○	○

④ 活接头材质 (Union material)	
UA	PVC Union
UB	CPVC Union

⑤ O-ring	
1	FKM
2	EPDM
5	DAI-EL G902

⑥ 附加功能 (Additional function)	
5	ON/OFF
6	流量调整功能 (Flow adjustment)

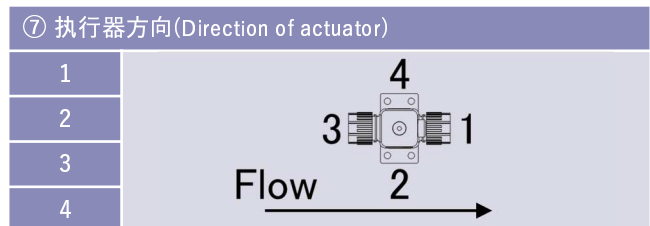

⑧ 固定 (Mounting)	
(No sign)	法兰固定 (Flange mounting)
B	底座固定 (Bottom mounting)

内部构造 (Internal structure)

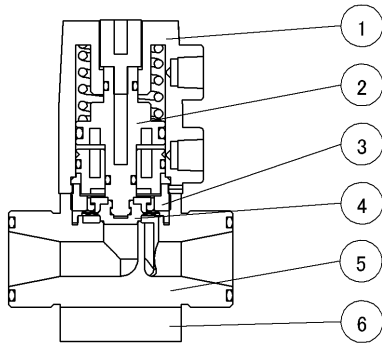

品号 (No)	零件名 (Parts name)	材质 (Material)
①	外壳 (Case)	PP
②	活塞 (Piston)	PP
③	填料式旋塞阀 (Stuffing)	PP
④	薄膜 (Diaphragm)	PTFE
⑤	本体 (Body)	可任选
⑥	底座 (Base)	PP

规格 (Specifications)

使用流体 (Fluid)	化学品·纯水·气体 (Chemical liquid, DIW, Gas) ※1		
流体温度 (Fluid temperature range) ※2	PVC	: 10~40°C	
	PTFE/CPVC/PP	: 10~80°C	
大气温度 (Atmospheric temperature)	0~40°C		
液体流动部分的材质 (Materials of liquid flowed parts)	本体 (Body)	: 可任选	
	薄膜 (Diaphragm)	: PTFE	
操作方式 (Operating system)	单动式 (Spring return actuation)		
气压压力 (Pneumatic supply pressure)	0.3~0.6MPa		
阀门尺寸 (Valve size)	15 (16A)	20 (20A)	25 (25A)
流通孔 (Orifice)	Φ10	Φ16	Φ22
流体压力 (Fluid pressure range)			
0.3MPa规格 (0.3MPa specification)	IN→OUT	0~0.3MPa	
	背压 (Back pressure)	0~0.3MPa	0~0.2MPa

PFA	Flare Type Flowell 60series	Pillar Super 300 Pillar Super flare	PTFE	Tube Fitting	PTFE (HI-TEMP)	Tube Fitting	Other	Union
-----	--------------------------------	--	------	--------------	-------------------	--------------	-------	-------

注释 (Note)

※1: 气体在最大1cm³/min的时候, 有可能会发生阀底座泄露。
 ※2: 本体的材质, 根据活接头的选择可能会发生不同。

尺寸 (Dimensions)

▶ 16A

SAP □ - 15 □ - □ □ - □ - 1 □

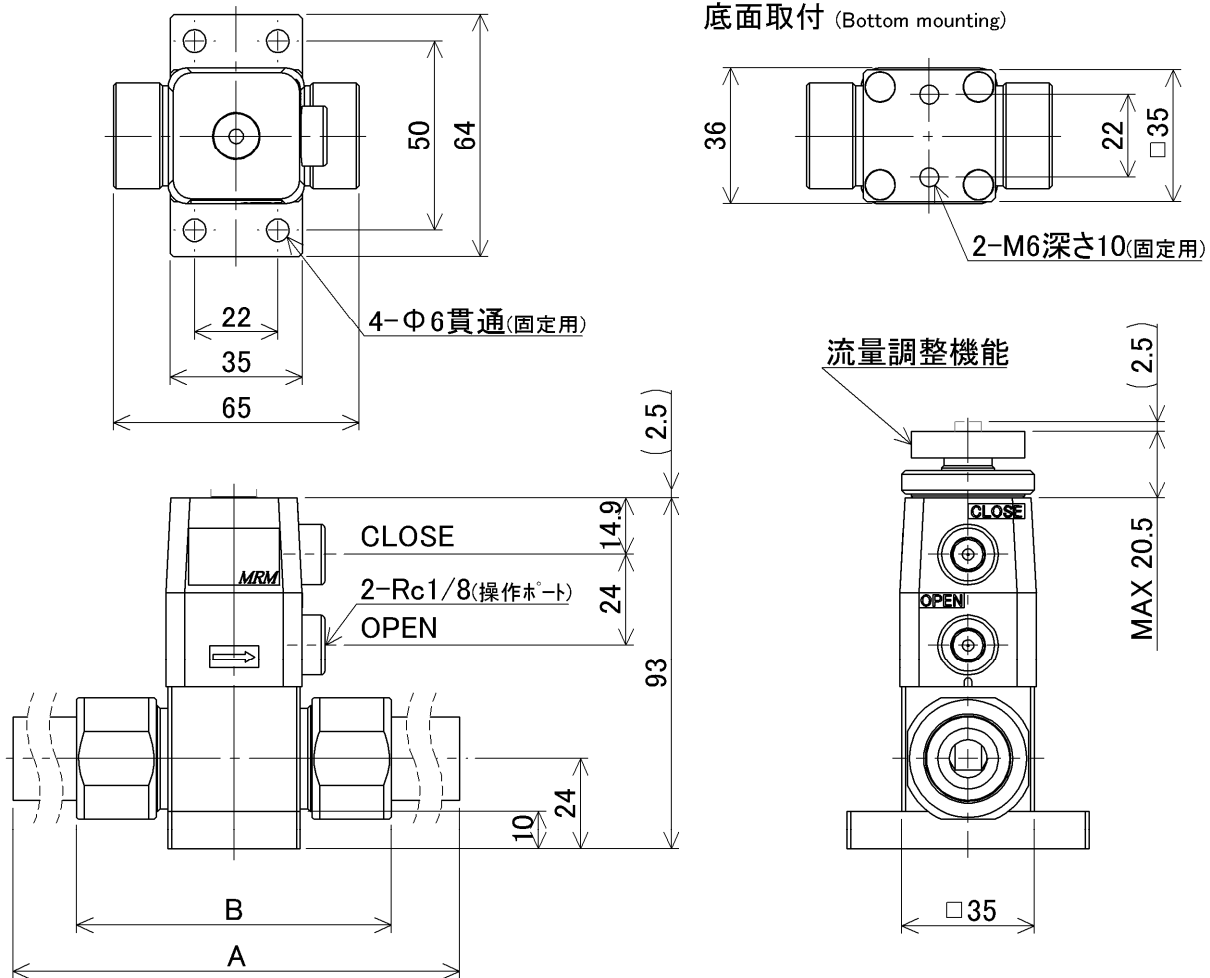

活接头材质 (Union material)	A	B
PVC Union	(233.2)	83.2
CPVC Union	235	86

追加采购用配管部品表 (Piping parts list for additional purchase)

件套 (SET) ※1	活接头 (Union)	O-ring		螺母(Nut)
A016U001-1-1-SET	PVC Union <u>A016U001-1</u>	FKM	<u>P18</u>	<u>A016N001</u>
A016U001-1-2-SET		EPDM	<u>P18-E</u>	
A016U001-1-5-SET		DAI-EL G902	<u>P18-D</u>	
A016U001-2-1-SET	CPVC Union <u>A016U001-2</u>	FKM	<u>P18</u>	
A016U001-2-2-SET		EPDM	<u>P18-E</u>	
A016U001-2-5-SET		DAI-EL G902	<u>P18-D</u>	

注释 (Note)

※1: 件套当中, 活接头、O-ring、螺母各包含一个。

尺寸 (Dimensions)

▶ 20A

SAP □ - 20 □ - □ □ - □ - 1 □

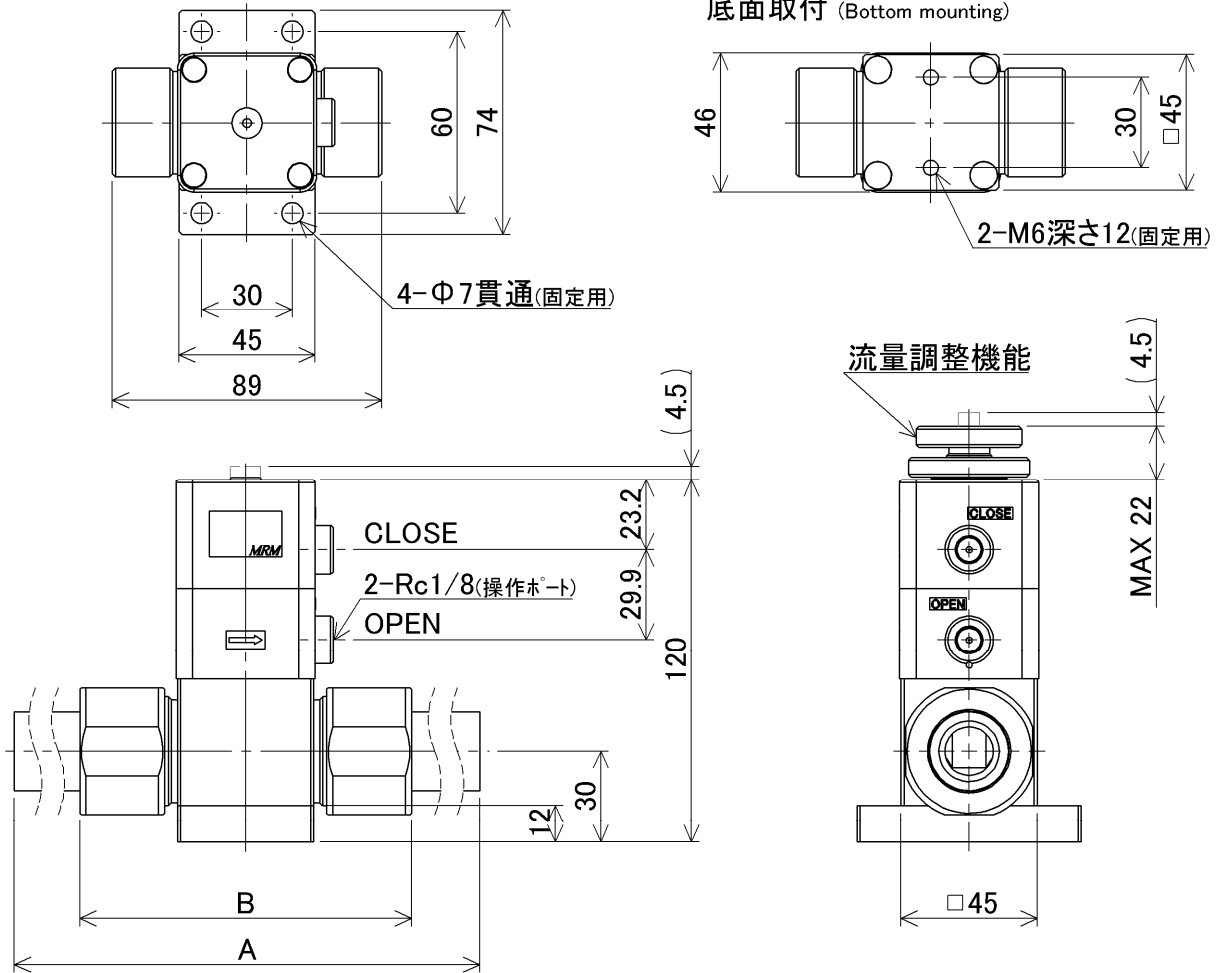

活接头材质 (Union material)	A	B
PVC Union	(267.6)	109.6
CPVC Union	269	110

追加采购用配管部品表 (Piping parts list for additional purchase)

件套 (SET) ※1	活接头(Union)	O-ring		螺母(Nut)
A020U001-1-1-SET	PVC Union <u>A020U001-1</u>	FKM	<u>P22</u>	<u>A020N001</u>
A020U001-1-2-SET		EPDM	<u>P22-E</u>	
A020U001-1-5-SET		DAI-EL G902	<u>P22-D</u>	
A020U001-2-1-SET	CPVC Union <u>A020U001-2</u>	FKM	<u>P22</u>	
A020U001-2-2-SET		EPDM	<u>P22-E</u>	
A020U001-2-5-SET		DAI-EL G902	<u>P22-D</u>	

注释 (Note)

※1:件套当中, 活接头、O-ring、螺母各包含一个。

PFA	Flare Type Flowell 60series	Pillar Super 300 Pillar Super flare	PTFE	Tube Fitting	PTFE (HI-TEMP)	Tube Fitting	Other	Union
-----	--------------------------------	--	------	--------------	-------------------	--------------	-------	-------

尺寸 (Dimensions)

▶ 25A

SAP □ - 25 □ - □ □ - □ - 1 □

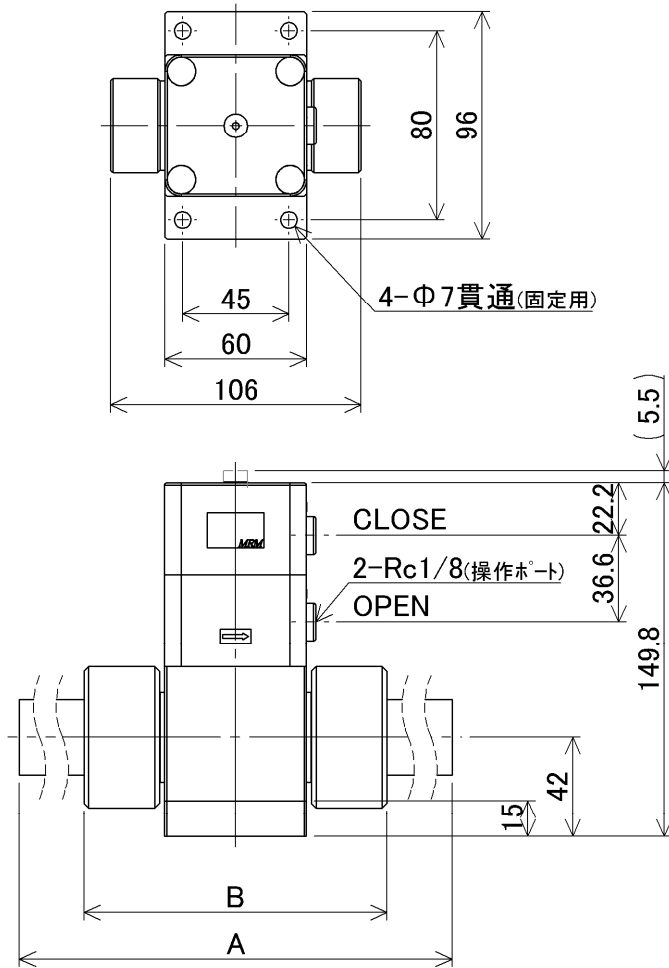

底面取付 (Bottom mounting)

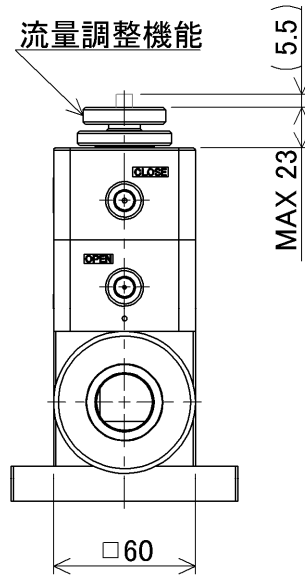
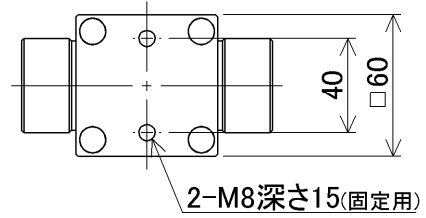

活接头材质 (Union material)	A	B
PVC Union	(304.2)	128.2
CPVC Union	296	129

追加采购用配管部品表 (Piping parts list for additional purchase)

件套 (SET) ※1	活接头 (Union)	O-ring		螺母 (Nut)
A025U001-1-1-SET	PVC Union A025U001-1	FKM	G30	A025N001
A025U001-1-2-SET		EPDM	G30-E	
A025U001-1-5-SET		DAI-EL G902	G30-D	
A025U001-2-1-SET	CPVC Union A025U001-2	FKM	G30	
A025U001-2-2-SET		EPDM	G30-E	
A025U001-2-5-SET		DAI-EL G902	G30-D	

注释 (Note)

※1: 件套当中, 活接头、O-ring、螺母各包含一个。

SAP (ON/OFF, Flow adjustment)

PFA	Flare Type Flowell 60series	Pillar Super 300 Pillar Super flare	PTFE	Tube Fitting	PTFE (HI-TEMP)	Tube Fitting	Other	Union
-----	--------------------------------	--	------	--------------	-------------------	--------------	-------	-------